

Accessories

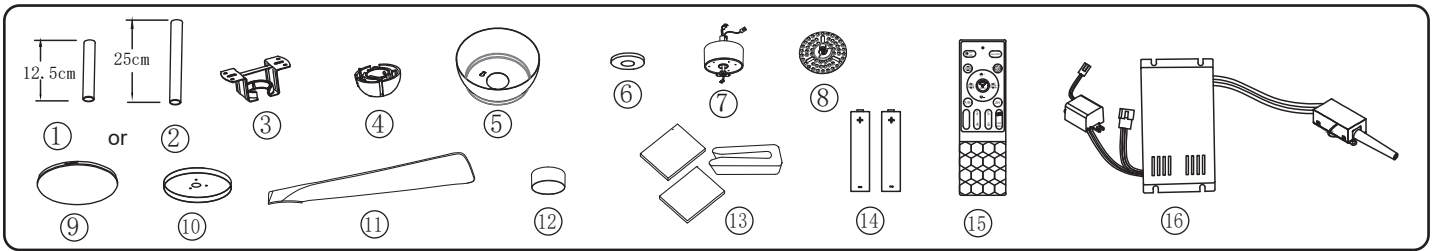

Install accessory package

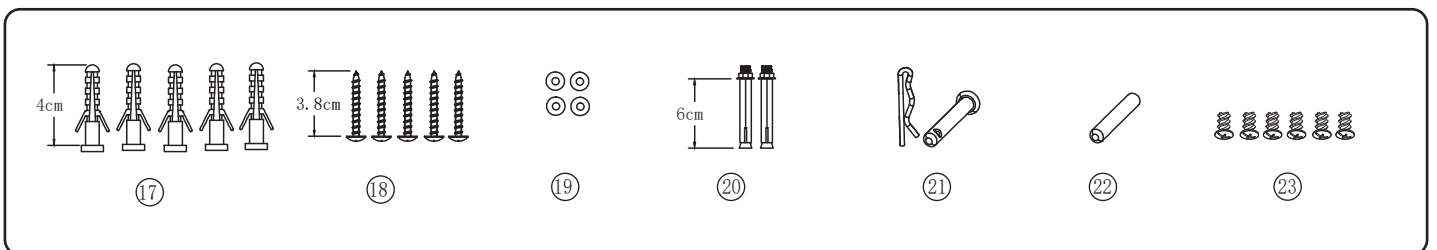

Preparation tools

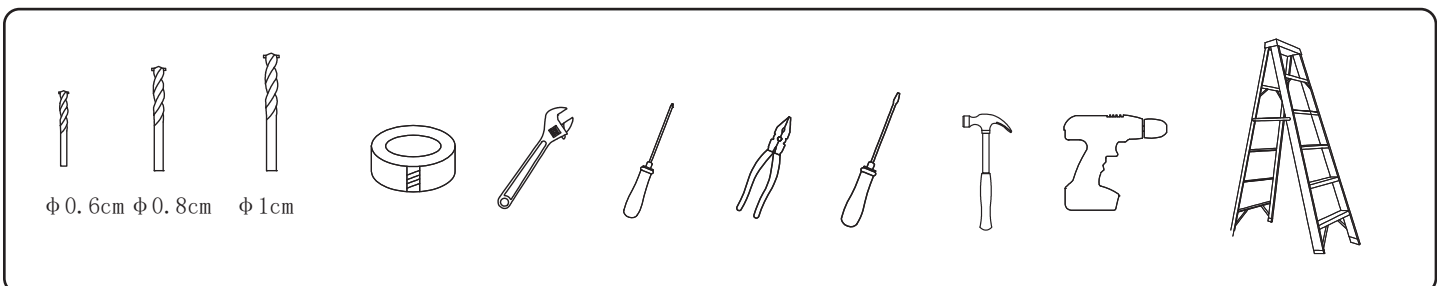

Installation steps

Fixed hanger

note: This product cannot be installed on gypsum ceilings. When installing on a solid wood ceiling, you need to make sure that the ceiling can bear at least 4 times the weight of the product before installation.

A. Wooden ceiling: Use 4 self-tapping screws to pass through the gasket and directly lock and fix it to the ceiling through the 4 round holes of the hanger.

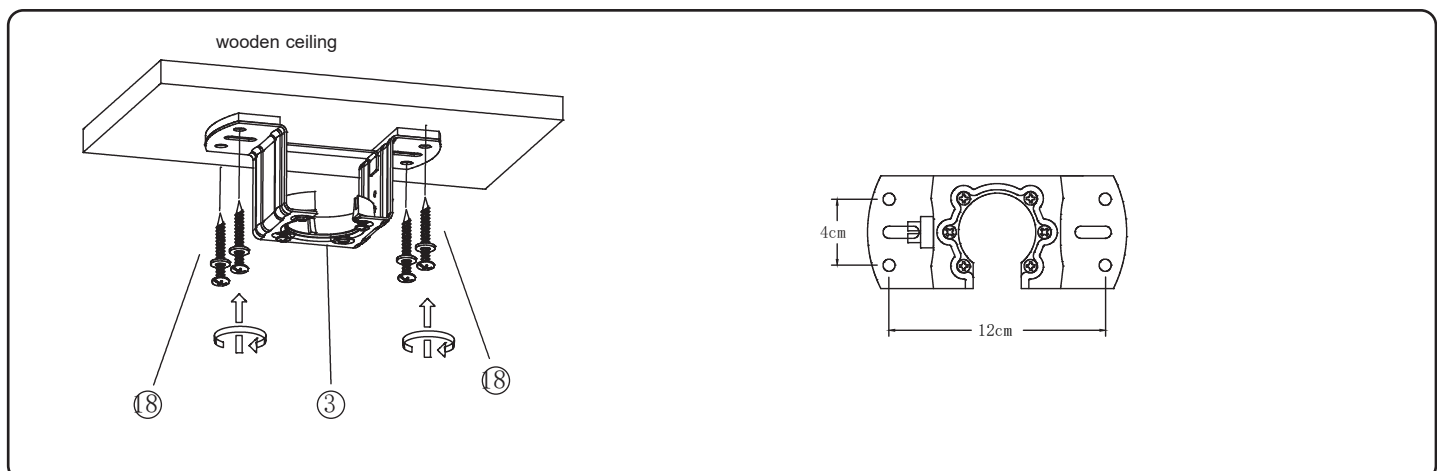

B. Concrete ceiling: Please use a 10mm impact drill to drill holes first, and then use M8 explosive screws to fix the hanger.

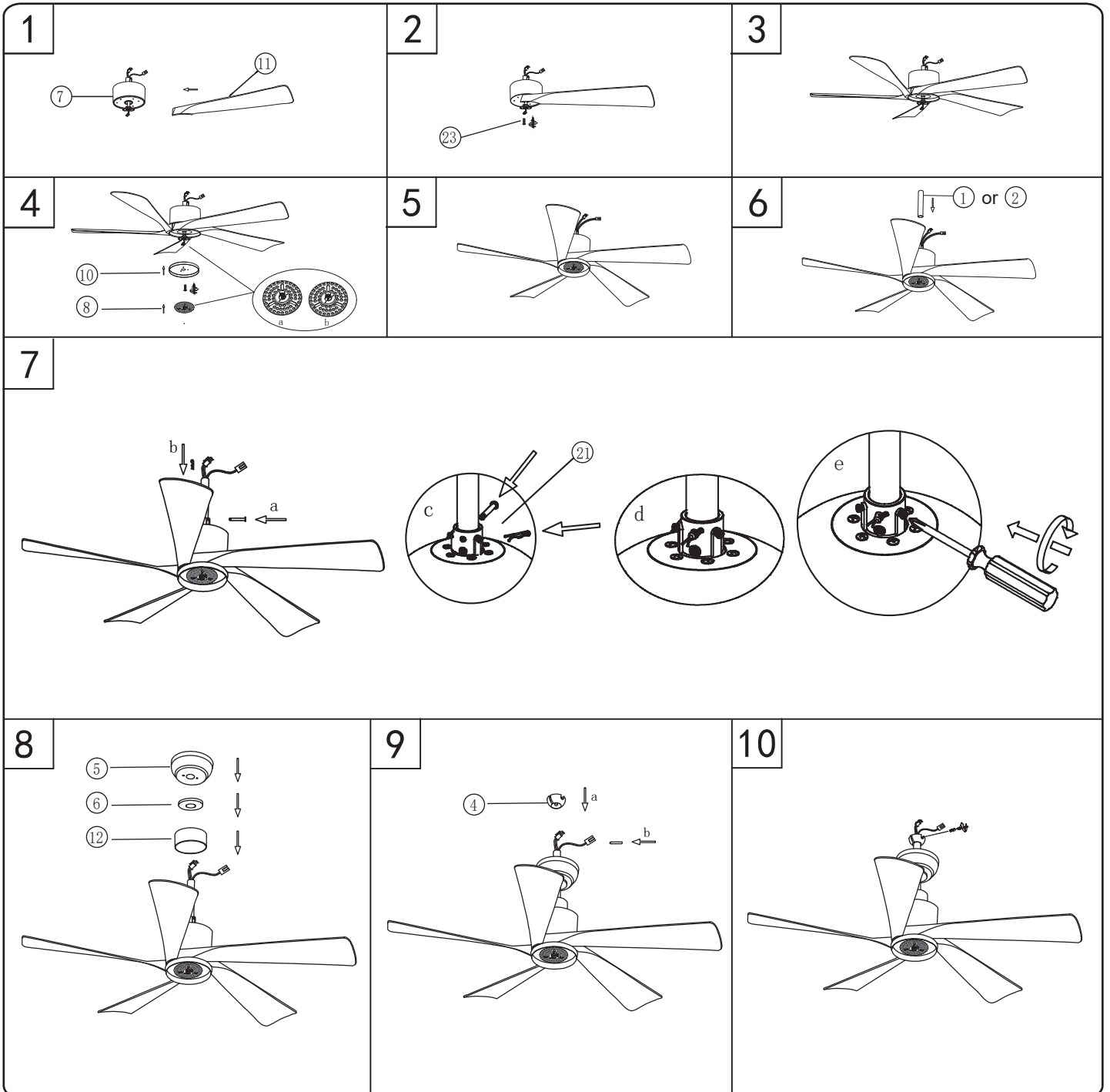
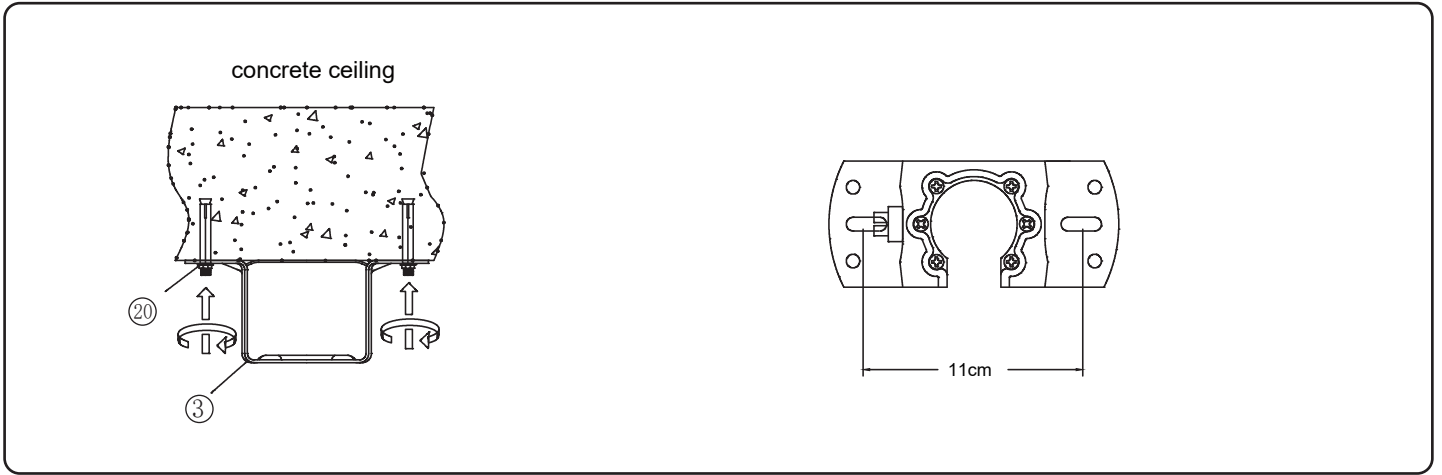

11

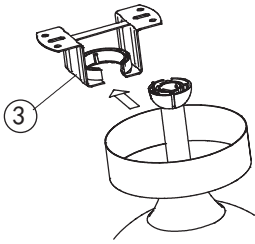

12

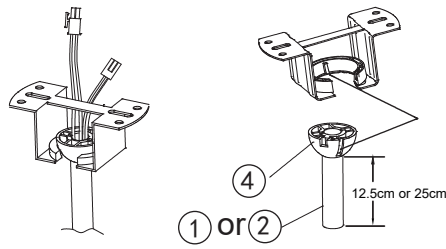

⚠ note:
Align the bumps with the grooves during assembly

13

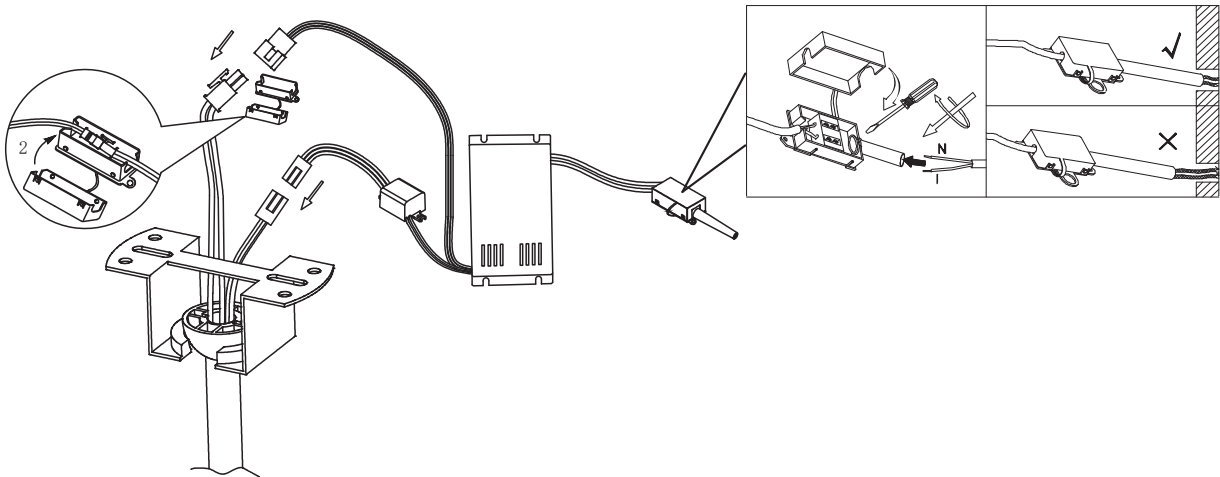

14

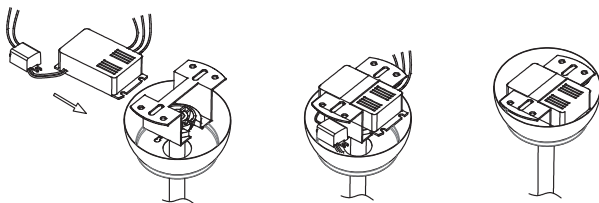

15

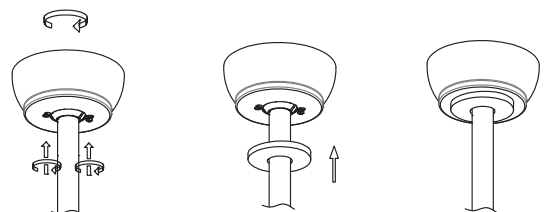

16

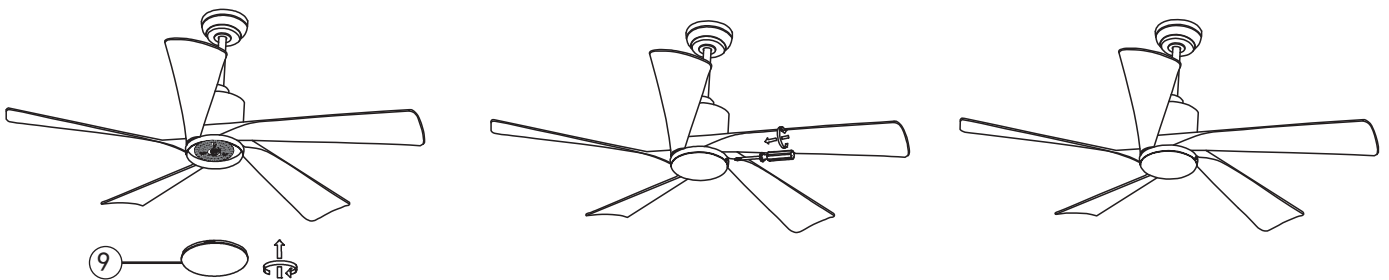

LED 20W SMD110-130V
220V-240V~ 50Hz

- colour fixing
- 36W max.
- incl.
- many light steps
- 3 light steps
2700 K - 6500 K
- 2700-6500K
- timer
- night light
- many steps
- dimmable
- memory function
- 220-240V 50Hz
- 6 steps
- 12-25m²

GLOBO Handels GmbH

Gewerbestrasse 3
A-9184 Sankt Peter, AUSTRIA
www.globo-lighting.com
office@globo-lighting.com

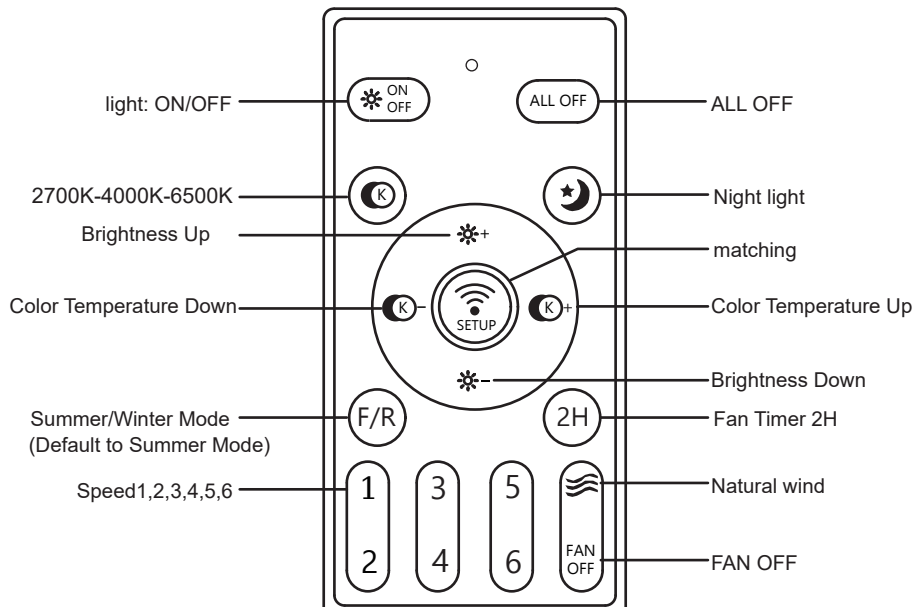
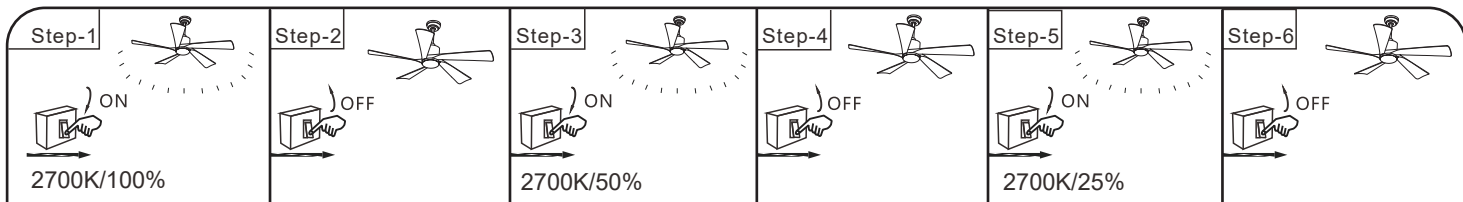

Frequency Bandwidth	Maximal radiation transmitting power
2400-2483.5MHz	<7dBm

Reset remote control

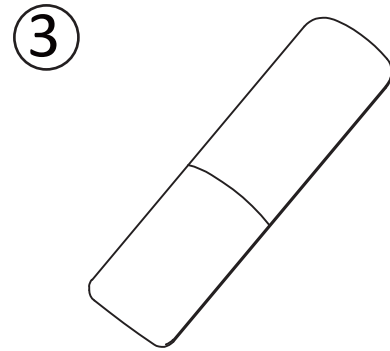
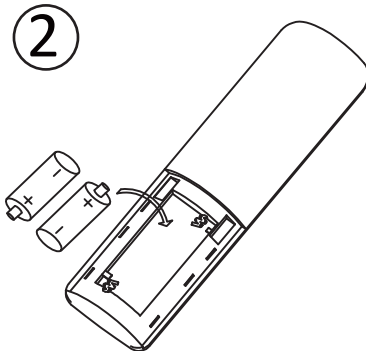
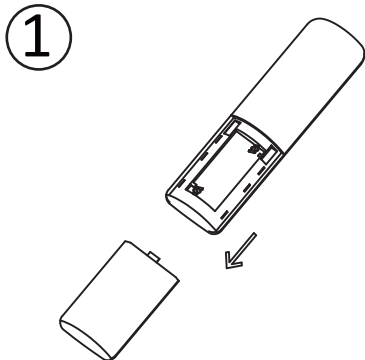
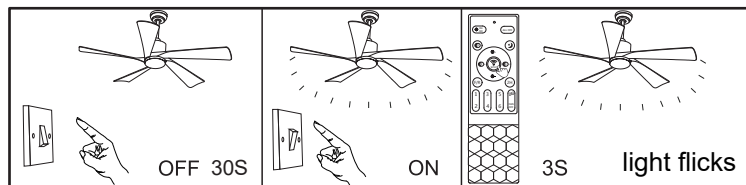

BATTERY DATA

2x LR03 Alkaline battery* incl.

*Manufacturer: Dongguan NuoXing Electronic Co., Ltd.
 Adress: 12 / F, building 14, Golden Town, No.7, Keji Avenue,
 Houjie Town, Dongguan City, Guangdong Province
 Model: LR03 SIZE AAA1.5V



SAFETY INSTRUCTIONS



Lichtquelle/Light source:

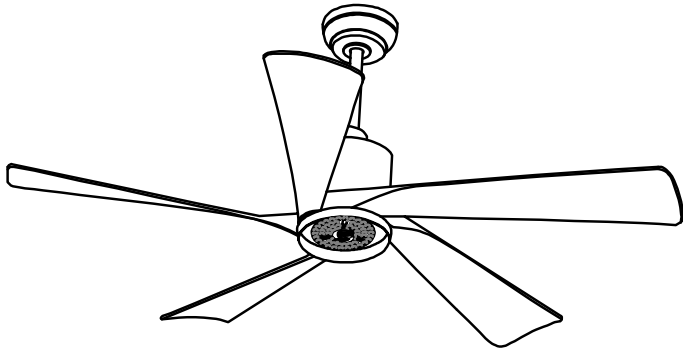

DEU:

Lichtquelle:

Die Lichtquelle ist nicht tauschbar, weil sie konstruktionsbedingt fest mit dem umgebenden Produkt verbunden ist.

Dieses Produkt enthält eine Lichtquelle der Energieeffizienzklasse <F>.



Die LED - Lichtquelle ist nicht austauschbar.

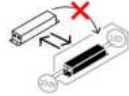

Das Betriebsgerät ist nicht austauschbar.
ausgetauscht werden.

GBR:

Light source:

The light source is not interchangeable because it is determined by the surrounding product design.

This product contains a light source of energy efficiency class <F>.



The LED - light source cannot be replaced.

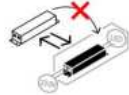

The control gear cannot be replaced.

BIH:

Izvor svjetla :

Izvor svjetla nije zamjenjiv , jer je konstrukcijski pričvršćen na proizvod .
Ovaj proizvod sadržava izvor svjetlosti klase energetske učinkovitosti <F>.



LED – izvor svjetla nije moguće zamjeniti

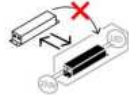

Pogonski uređaj se ne može zamjeniti .

BG:

Източник на светлина:

Източникът на светлина не може да се подменя, тъй като поради конструкцията си е трайно фиксиран към заобикалящия го продукт.
Този продукт включва светлинен източник с клас на енергийна ефективност <F>.



LED източникът на светлина не може да се подменя.

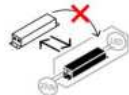

Устройството за управление не може да се

CZ:

Zdroj světla:

Světelný zdroj není možné vyměnit, protože je díky své konstrukci pevně spojený s produktem.

Tento výrobek obsahuje světelný zdroj s třídou energetické účinnosti <F>.



Světelný zdroj není vyměnitelný.

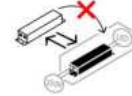

Předřadník není vyměnitelný.

DK:

Lyskilde:

Lyskilden kan ikke udskiftes, fordi den er fast forbundet med det omgivende produkt.

Dette produkt indeholder en lyskilde i energieffektivitetsklasse <F>.



LED- lyskilden kan ikke udskiftes.

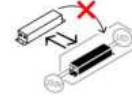

Driftsenheden kan ikke udskiftes.

ET:

Valgusallikas:

Valgusallikas ei ole välja vahetatav, sest ta on tootega ehituslikult kindlalt seotud.

Toode sisaldab energiatõhususe klassi <F> valgusallikat.



LED - valgusallikat ei saa asendada.



Juhtseadet ei saa asendada.

FI:

Valonlähde:

Valonlähdettä ei voi vaihtaa uuteen, sillä se on rakenteellisesti yhdistetty ympäröivään tuotteeseen.

Tämä tuote sisältää valonlähteen, jonka energiatehokkuusluokka on <F>.



LED-valonlähdettä ei voi vaihtaa uuteen.

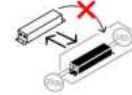

Liitäntälaitetta ei voi vaihtaa uuteen.

FR:

Source lumineuse:

La source lumineuse n'est pas remplaçable car elle est, de par la construction du produit, liée de façon permanente à celui-ci.

Ce produit contient une source lumineuse de classe d'efficacité énergétique <F>.



La source lumineuse LED n'est pas remplaçable.



L'unité de contrôle n'est pas remplaçable.

GR:

Φωτεινή πηγή:

Η φωτεινή πηγή δεν μπορεί να αντικατασταθεί, επειδή είναι για κατασκευαστικούς λόγους σταθερά συνδεδεμένη με το προϊόν που την περιβάλλει.

Το προϊόν αυτό περιέχει φωτεινή πηγή της τάξης ενεργειακής απόδοσης <F>.



Η φωτεινή πηγή LED δεν αντικαθίσταται.

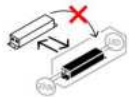

Η λειτουργική συσκευή δεν αντικαθίσταται.

HU:

Fényforrás:

A fényforrás nem cserélhető, mert felépítése miatt szilárdan csatlakozik a termékhez.

Ez a termék egy <F> energiahatékonysági osztályú fényforrást tartalmaz.



A fényforrás nem cserélhető.



Az előttét nem cserélhető.

Isländisch/IS:

Ljósgrjafi:

Ljósgrjafinn er ekki útskiptanlegur vegna þess að hann er háður umliggjandi hönnun vörunnar.

Varan inniheldur ljósgrjafa í orkuflokki <F>.



Ekki er hægt að skipta um LED-ljósgrjafann.

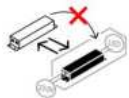

Ekki er hægt að skipta um stjórnbúnaðinn.

IT:

Sorgente luminosa:

La sorgente luminosa non è intercambiabile perché è saldamente collegata al prodotto per via del suo design.

Questo prodotto contiene una sorgente luminosa di classe di efficienza energetica <F>.



La sorgente luminosa a LED non può essere sostituita.

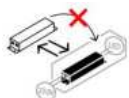

La centralina non può essere sostituita.

HR:

Izvor svjetla:

Izvor svjetla nije zamjenjiv, jer je konstrukcijski pričvršćen na proizvod.

Ovaj proizvod sadržava izvor svjetlosti klase energetske učinkovitosti <F>.



LED – izvor svjetla nije moguće zamjeniti.

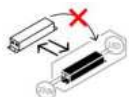

Pogonski uređaj se ne može zamjeniti.

LV:

Gaismas avots:

Gaismas avotu nevar nomainīt, jo tas konstrukcijā ir cieši savienots ar izstrādājuma apkārtējo daļu.

Šis ražojums satur gaismas avotu, kura energoefektivitātes klase ir <F>.



LED apgaismes līdzekļi nevar nomainīt.

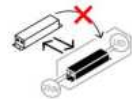

Vadības ierīci nevar nomainīt.

LT:

Šviesos šaltinis:

Šis šviesos šaltinis yra nekeičiamas, nes jis prijungtas prie gaminio pagal jo konstrukciją.

Šiame gaminyje yra šviesos šaltinis, kurio energijos vartojimo efektyvumo klasė <F>.



LED šviesos šaltinis yra nekeičiamas.

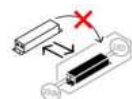

Valdymo įtaisas yra nekeičiamas.

NL:

Lichtbron:

De lichtbron kan niet worden vervangen, omdat deze vanwege de constructie vast met het product eromheen verbonden is.

Dit product bevat een lichtbron van energie-efficiëntieklasse <F>.



De LED-lichtbron kan niet worden vervangen.

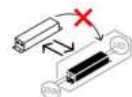

Het apparaat kan niet worden vervangen.

Norwegisch/Norwegian / NO:

Lyskilde:

Lyskilden kan ikke byttes fordi den sitter fast i produktet.

Dette produktet inneholder en lyskilde i energiklasse <F>.



LED-lyspæren kan ikke byttes.

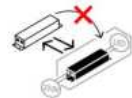

Driverenheten kan ikke byttes.

PL:

Źródło światła:

Źródła światła nie można wymienić, ponieważ jest zintegrowane z produktem ze względu na swoją konstrukcję.

Ten produkt zawiera źródło światła o klasie efektywności energetycznej <F>.



LED - źródło światła nie może być wymienione.



Nie można wymienić przekładni sterującej.

PT:

Fonte de Luz:

A fonte de luz não é substituível porque devido às suas características construtivas está fixada de forma permanente ao produto circundante. Este produto contém uma fonte de luz da classe de eficiência energética <F>.



Lâmpada não substituível.



Equipamento de controlo não substituível.

RO:

Sursa de lumina:

Sursa de lumina nu este inlocuibila ea fiind parte constructiva a produsului

Acest produs conține o sursă de lumină cu clasa de eficiență energetică <F>.



Sursa de lumina nu poate fi inlocuita

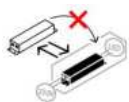

Driverul nu poate fi inlocuit

RUS:

Источник света:

Источник света не является взаимозаменяемым, поскольку это определяется конструкцией смежного продукта.

Данный продукт содержит источник света класса энергоэффективности <F>.



Светодиодный источник света не подлежит замене.

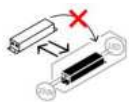

Устройство управления не подлежит замене.

SRB:

Izvor svetlosti:

Izvor svetlosti nije zamenljiv, jer je zbog svog dizajna čvrsto povezan sa proizvodom koji ga opkružuje.

Ovaj proizvod sadrži izvor svetlosti klase energetske efikasnosti <F>.



LED izvor svetlosti nije zamenljiv.

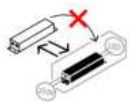

Upravljački uređaj nije zamenljiv.

SK:

Zdroj svetla:

Svetelný zdroj nie je možné vymeniť, pretože je vďaka svojej konštrukcii pevne spojený s produktom.

Tento výrobok obsahuje svetelný zdroj triedy energetickej účinnosti <F>.



Svetelný zdroj nie je vymeniteľný.

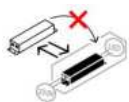

Predradník nie je vymeniteľný.

SI:

Izvor svetlobe:

Vir svetlobe ni zamenljiv, ker je določen z zasnovo izdelka v okolici.

Ta izdelek vsebuje svetlobni vir razreda energijske učinkovitosti <F>.



Svetlobni vir ni mogoče zamenjati.

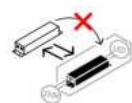

Krmilnik ni mogoče zamenjati.

ES:

Fuente de luz:

La fuente de luz no es sustituible porque está fija en el producto desde la construcción.

Este producto contiene una fuente luminosa de la clase de eficiencia energética <F>.



Bombilla no reemplazable.

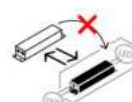

Dispositivo de control no reemplazable.

SE:

Ljuskälla:

Ljuskällan är inte utbytbar, eftersom den på grund av konstruktionen är fast integrerad i den omgivande produkten.

Denna produkt innehåller en ljuskälla med energieffektivitetsklass <F>.



LED-ljuskällan kan inte bytas ut.

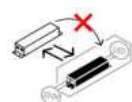

Driftdonet kan inte bytas ut.

TR:

Işık kaynağı:

Konstrüksiyon gereği çevreleyen ürün ile sabit bir şekilde bağlı olduğu için ışık kaynağı değiştirilemez.

Bu ürün, <F> enerji sınıfından bir ışık kaynağına sahiptir.



LED ışık kaynağı değiştirilemez.

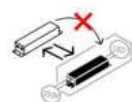

İşletme cihazı değiştirilemez.

UK:

Джерело світла:

Джерело світла не можна обміняти, оскільки воно міцно пов'язане з навколишнім виробом завдяки своїй конструкції.

Цей виріб містить джерело світла класу енергоефективності <F>.



– джерело світлодіодного світла не можна замінювати.



– пристрій керування не можна замінювати.