

GLOBO

LIGHTING

416080AD5-CCT

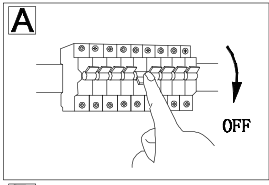

B

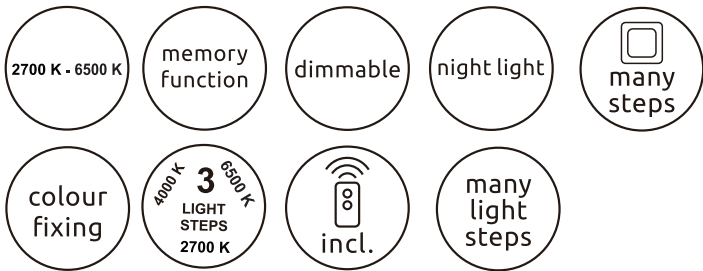
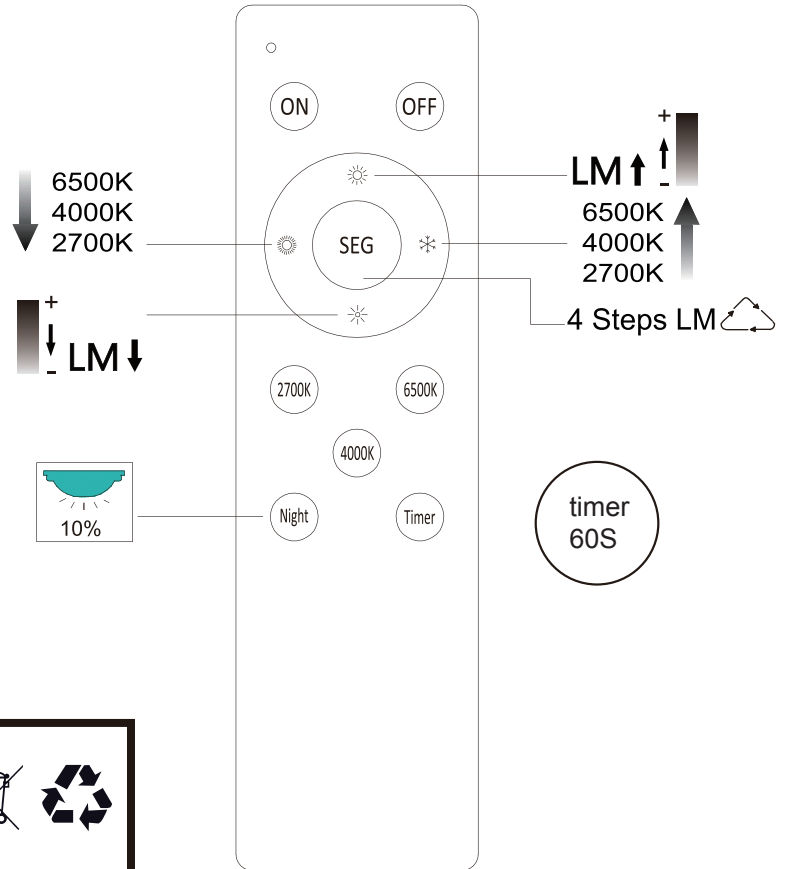
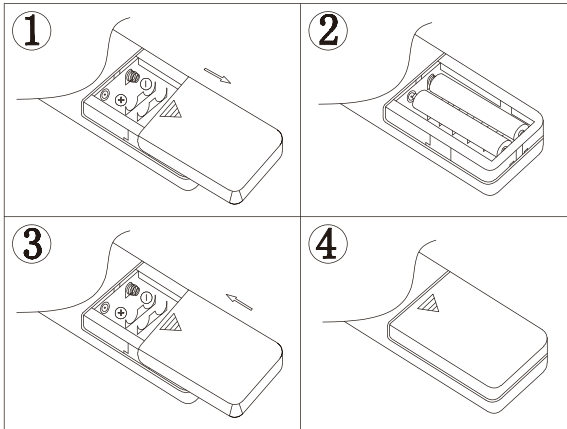
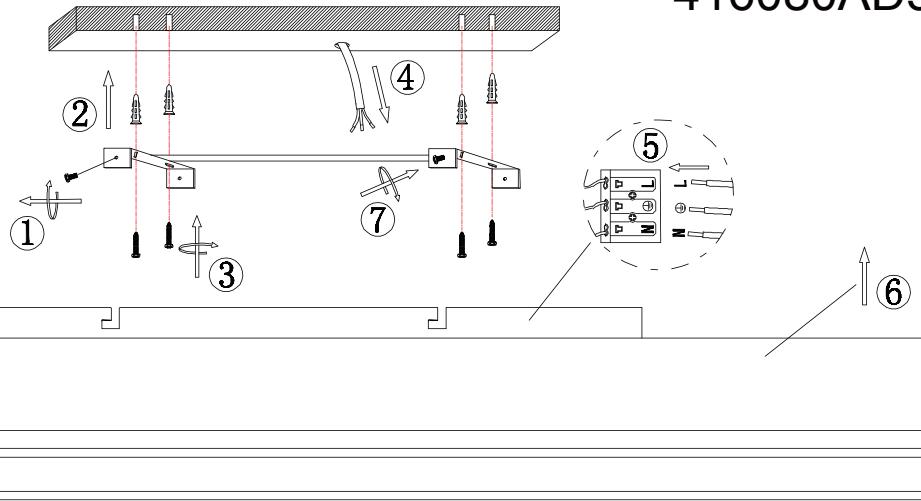

BATTERY DATA

2x AAA battery* incl.

*Manufacturer: SHENZHEN GMCELL TECHNOLOGY CO.,LTD
Address: Hualian Panorama International Building, 27 District,
Bao'an, Shenzhen, China
Model: R03P, 1.5V



SAFETY INSTRUCTIONS



1x 36W LED 126-136V
220-240V~ 50/60Hz

GLOBO Handels GmbH
Gewerbestr. 3
A-9184 Sankt Peter, Austria
www.globo-lighting.com
office@globo-lighting.com

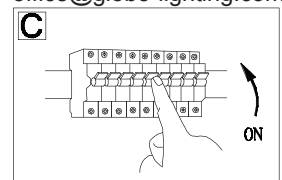
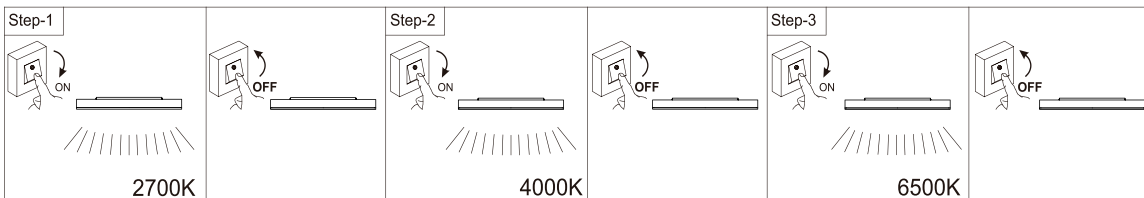

Lichtquelle:

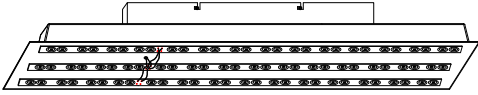

DEU

Lichtquelle:

Die Lichtquelle ist nicht tauschbar, weil sie konstruktionsbedingt fest mit dem umgebenden Produkt verbunden ist.

Dieses Produkt enthält eine Lichtquelle der Energieeffizienzklasse <F>.



Das Betriebsgerät kann nur durch einen Fachmann ausgetauscht werden.



Die LED - Lichtquelle ist nicht austauschbar.

GBR:

Light source:

The light source is not interchangeable because it is determined by the surrounding product design.

This product contains a light source of energy efficiency class <F>.



The control gear can be replaced by a professional.



The LED - light source cannot be replaced.

BG:

Източник на светлина:

Източникът на светлина не може да се подменя, тъй като поради конструкцията си е трайно фиксиран към заобикалящия го продукт. Този продукт включва светлинен източник с клас на енергийна ефективност <F>.



Устройството за управление може да се подменя само от специалист.



LED източникът на светлина не може да се подменя.

BIH:

Izvor svjetla :

Izvor svjetla nije zamjenjiv , jer je konstrukcijski pričvršćen na proizvod. Ovaj proizvod sadržava izvor svjetlosti klase energetske učinkovitosti <F>.



Pogonski uređaj smije zamjeniti samo stručna osoba .



LED – izvor svjetla nije moguće zamjeniti

CZ:

Zdroj světla:

Světelný zdroj není možné vyměnit, protože je díky své konstrukci pevně spojený s produktem. Tento výrobek obsahuje světelný zdroj s třídou energetické účinnosti <F>.



Výměna předřadníku pouze odborníkem.



Světelný zdroj není vyměnitelný.

DK:

Lyskilde:

Lyskilden kan ikke udskiftes, fordi den er fast forbundet med det omgivende produkt. Dette produkt indeholder en lyskilde i energieffektivitetsklasse < F > .



Driftsenheden kan kun skiftes af en fagperson.



LED- lyskilden kan ikke udskiftes.

ET:

Valgusallikas:

Valgusallikas ei ole välja vahetatav, sest ta on tootega ehituslikult kindlalt seotud. Toode sisaldab energiatõhususe klassi <F> valgusallikat.



Juhtseadmed võib asendada professionaalne.



LED - valgusallikat ei saa asendada.

ES:

Fuente de luz:

La fuente de luz no es sustituible porque está fija en el producto desde la construcción. Este producto contiene una fuente luminosa de la clase de eficiencia energética <F>.



Sustitución del aparato por un profesional.



Bombilla no reemplazable.

FI:

Valonlähde:

Valonlähde ei voi vaihtaa uuteen, sillä se on rakenteellisesti yhdistetty ympäröivään tuotteeseen. Tämä tuote sisältää valonlähteen, jonka energiatehokkuusluokka on <F>.



Vain ammattihenkilö voi vaihtaa liitäntälaitteen.



LED-valonlähde ei voi vaihtaa uuteen.

FR:

Source lumineuse:

La source lumineuse n'est pas remplaçable car elle est, de par la construction du produit, liée de façon permanente à celui-ci.

Ce produit contient une source lumineuse de classe d'efficacité énergétique <F>.



L'unité de contrôle ne peut être remplacée que par un spécialiste.



La source lumineuse LED n'est pas remplaçable.

GR:

Φωτεινή πηγή:

Η φωτεινή πηγή δεν μπορεί να αντικατασταθεί, επειδή είναι για κατασκευαστικούς λόγους σταθερά συνδεδεμένη με το προϊόν που την περιβάλλει. Το προϊόν αυτό περιέχει φωτεινή πηγή της τάξης ενεργειακής απόδοσης <F>.



Η λειτουργική συσκευή μπορεί να αντικατασταθεί μόνο από έναν ειδικό.



Η φωτεινή πηγή LED δεν αντικαθίσταται.

HR:

Izvor svjetla :

Izvor svjetla nije zamjenjiv , jer je konstrukcijski pričvršćen na proizvod . Ovaj proizvod sadržava izvor svjetlosti klase energetske učinkovitosti <F>.



Pogonski uređaj smije zamjeniti samo stručna osoba .



LED – izvor svjetla nije moguće zamjeniti

HU:

Fényforrás:

A fényforrás nem cserélhető, mert felépítése miatt szilárdan csatlakozik a termékhez. Ez a termék egy <F> energiatékonysági osztályú fényforrást tartalmaz.



Az előtétet csak szakértők cserélhetik ki.



A fényforrás nem cserélhető

IS:

Ljósgjafi:

Ljósgjafinn er ekki útskiptanlegur vegna þess að hann er háður umliggjandi hönnun vörunnar. Varan inniheldur ljósgjafa í orkuflokki <F>.



Aðeins fagmenn mega skipta um stjórnbúnaðinn..



EKKI er hægt að skipta um LED-ljósgjafann.

IT:

Sorgente luminosa:

La sorgente luminosa non è intercambiabile perché è saldamente collegata al prodotto per via del suo design.

Questo prodotto contiene una sorgente luminosa di classe di efficienza energetica <F>.



L'alimentatore può essere sostituito solo da personale specializzato.



La sorgente luminosa a LED non può essere sostituita.

LT:

Šviesos šaltinis:

Šis šviesos šaltinis yra nekeičiamas, nes jis prijungtas prie gaminio pagal jo konstrukciją. Šiame gaminyje yra šviesos šaltinis, kurio energijos vartojimo efektyvumo klasė <F>.



Valdymo įtaisą gali pakeisti tik tam kvalifikuotas specialistas.



LED šviesos šaltinis yra nekeičiamas.

LV:

Gaismas avots:

Gaismas avotu nevar nomainīt, jo tas konstrukcijā ir cieši savienots ar izstrādājuma apkārtnējo daļu.

Šis ražojums satur gaismas avotu, kura energoefektivitātes klase ir <F>.



Vadības ierīci var nomainīt speciālists.



LED apgaismes līdzekli nevar nomainīt.

NL:

Lichtbron:

De lichtbron kan niet worden vervangen, omdat deze vanwege de constructie vast met het product eromheen verbonden is.

Dit product bevat een lichtbron van energie-efficiëntieklasse <F>.



Het apparaat kan alleen door een vakman worden vervangen.



De LED-lichtbron kan niet worden vervangen.

NO:

Lyskilde:

Lyskilden kan ikke byttes fordi den sitter fast i produktet. Dette produktet inneholder en lyskilde i energiklasse <F>.



Driverenheten kan kun byttes av fagmann.



LED-lyspæren kan ikke byttes.

PL:Źródło światła:

Źródła światła nie można wymienić, ponieważ jest zintegrowane z produktem ze względu na swoją konstrukcję.

Ten produkt zawiera źródło światła o klasie efektywności energetycznej <F>.



Urządzenie sterujące może zostać wymienione przez specjalistę.



LED - źródło światła nie może być wymienione.

PT:Fonte de Luz:

A fonte de luz não é substituível porque devido às suas características construtivas está fixada de forma permanente ao produto circundante. Este produto contém uma fonte de luz da classe de eficiência energética <F>.



Substituição do equipamento de controlo por um profissional.



Lâmpada não substituível.

RO:Sursa de lumina:

Sursa de lumina nu este inlocuibilă ea fiind parte constructivă a produsului. Acest produs conține o sursă de lumină cu clasă de eficiență energetică <F>.



Driverul poate fi inlocuit doar de către personal specializat



Sursa de lumina nu poate fi înlocuită

RUS:Источник света:

Источник света не является взаимозаменяемым, поскольку это определяется конструкцией смежного продукта.

Данный продукт содержит источник света класса энергоэффективности <F>.



Устройство управления может заменяться только квалифицированным специалистом.



Светодиодный источник света не подлежит замене.

SE:Ljuskälla:

Ljuskällan är inte utbytbar, eftersom den på grund av konstruktionen är fast integrerad i den omgivande produkten.

Denna produkt innehåller en ljuskälla med energieffektivitetsklass <F>.



Driftdonet kan endast bytas ut av en fackman.



LED-ljuskällan kan inte bytas ut.

SI:Izvor svetlobe:

Vir svetlobe ni zamenljiv, ker je določen z zasnovo izdelka v okolici. Ta izdelek vsebuje svetlobni vir razreda energijske učinkovitosti <F>.



Krmilno napravo lahko zamenja samo strokovno usposobljena oseba



Svetlobni vir ni mogoče zamenjati.

SK:Zdroj svetla:

Svetelný zdroj nie je možné vymeniť, pretože je vďaka svojej konštrukcii pevne spojený s produktom.

Tento výrobok obsahuje svetelný zdroj triedy energetickej účinnosti <F>.



Výmena predradníka len odborníkom.



Svetelný zdroj nie je vymeniteľný.

SRB:Izvor svetlosti:

Izvor svetlosti nije zamenljiv, jer je zbog svog dizajna čvrsto povezan sa proizvodom koji ga opkružuje.

Ovaj proizvod sadrži izvor svetlosti klase energetske efikasnosti <F>.



Upravljački uređaj može da zameni samo specijalista.



LED izvor svetlosti nije zamenljiv.

TR:Işık kaynağı:

Konstrüksiyon gereği çevreleyen ürün ile sabit bir şekilde bağlı olduđu için ışık kaynağı değiştirilemez.

Bu ürün, <F> enerji sınıfından bir ışık kaynağına sahiptir.



İşletme cihazı sadece bir uzman tarafından değiştirilebilir.



LED ışık kaynağı değiştirilemez.

UK:Джерело світла:

Джерело світла не можна обміняти, оскільки воно міцно пов'язане з навколишнім виробом завдяки своїй конструкції.

Цей виріб містить джерело світла класу енергоефективності <F>.



– лише фахівець може замінювати пристрій керування.



– джерело світлодіодного світла не можна замінювати.