

**71077**  
**END TABLE**  
**HOEKTAFEL**

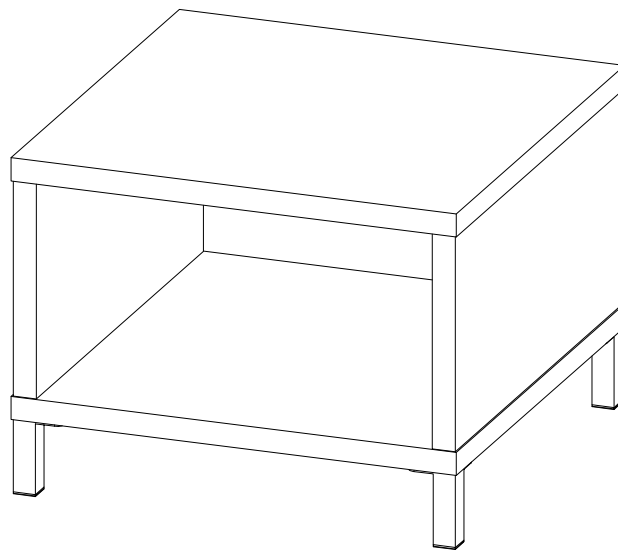

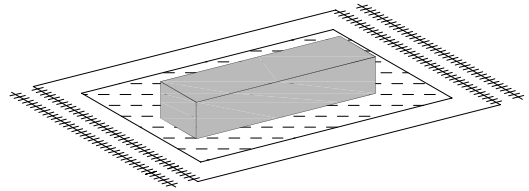

①	x 1	②	x 10	③	x 4	④	x 4	⑤	x 6
	15g		$\phi 8 \times 30\text{mm}$		35mm		$\phi 15 \times 12\text{mm}$		55mm
⑥	x 4	⑦	x 8	⑧	x 4	⑨	x 1	⑩	
	30 x 30 x 97mm		$\phi 5 \times 20\text{mm}$		30 x 30mm		$\phi 20\text{mm}$		

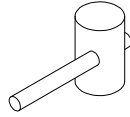
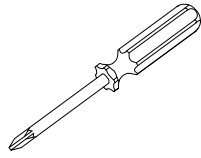
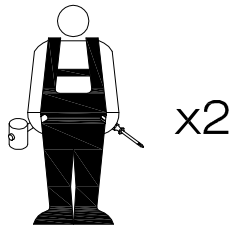
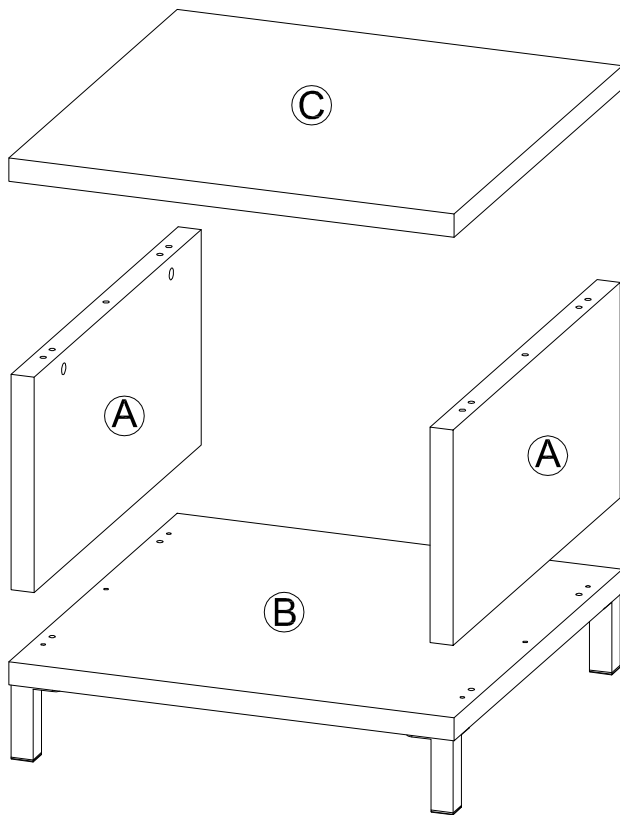

## PARTS IDENTIFICATION : BESCHRIJVING ONDERDELEN :

(A) LEFT SIDE PANEL  
(A) ZIJPANEEL LINKS

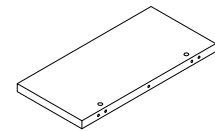

2PCS

(B) LEFT CROSS BRACE  
(B) ONDERREGEL LINKS

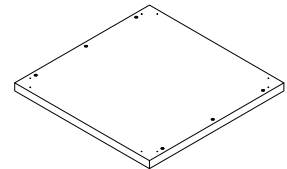

1PC

(C) LONG CROSS BRACE  
(C) ONDERREGEL VOOR

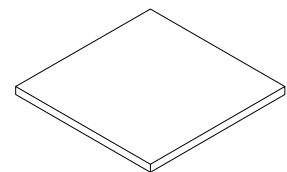

1PC

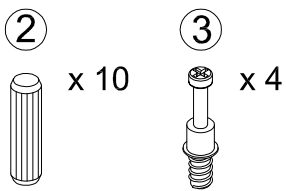

1

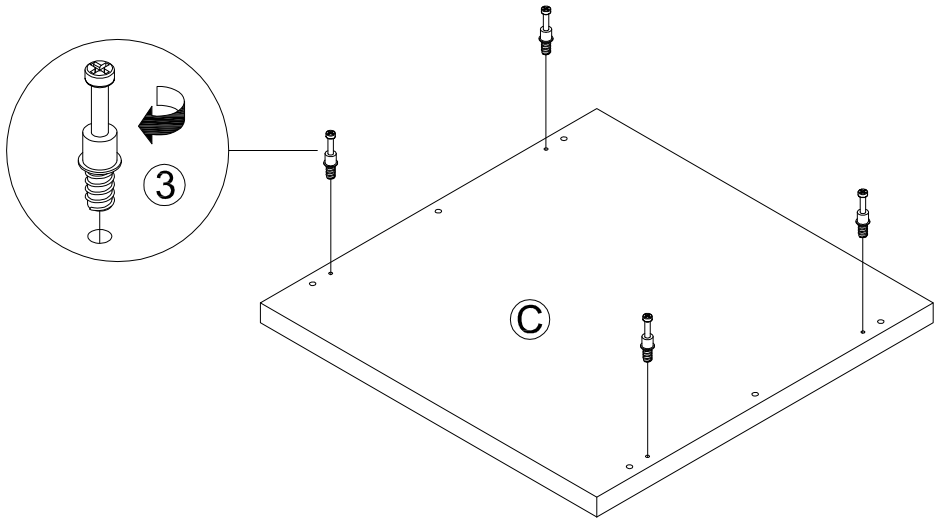

2

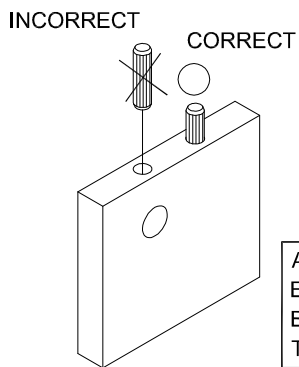
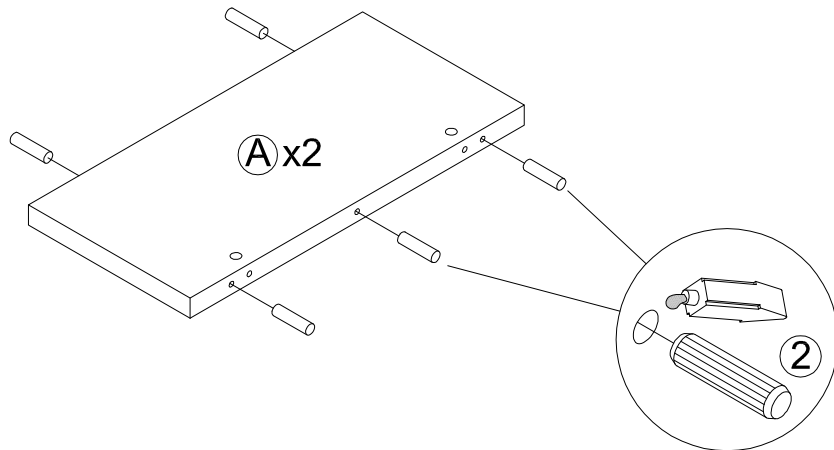

APPLY GLUE ON ALL WOODEN DOWELS TO ENSURE INTEGRITY OF THE STRUCTURE.  
BRENG LIJM AAN OP ALLE HOUTEN DEUVELS TEN BEHOEVE VAN DE STEVIGHEID.

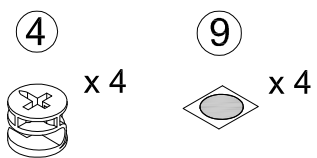

3

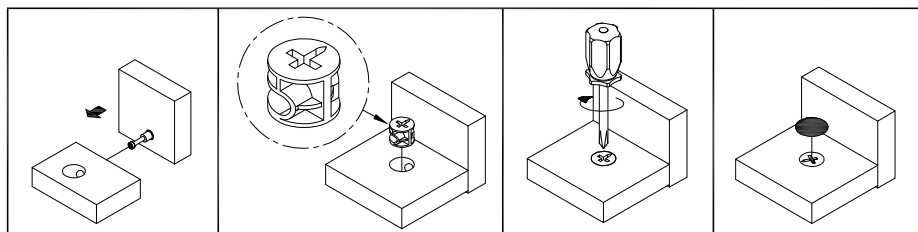
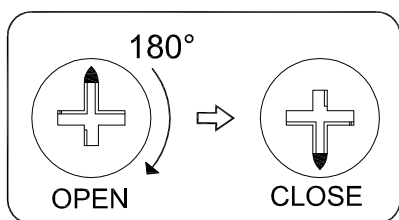
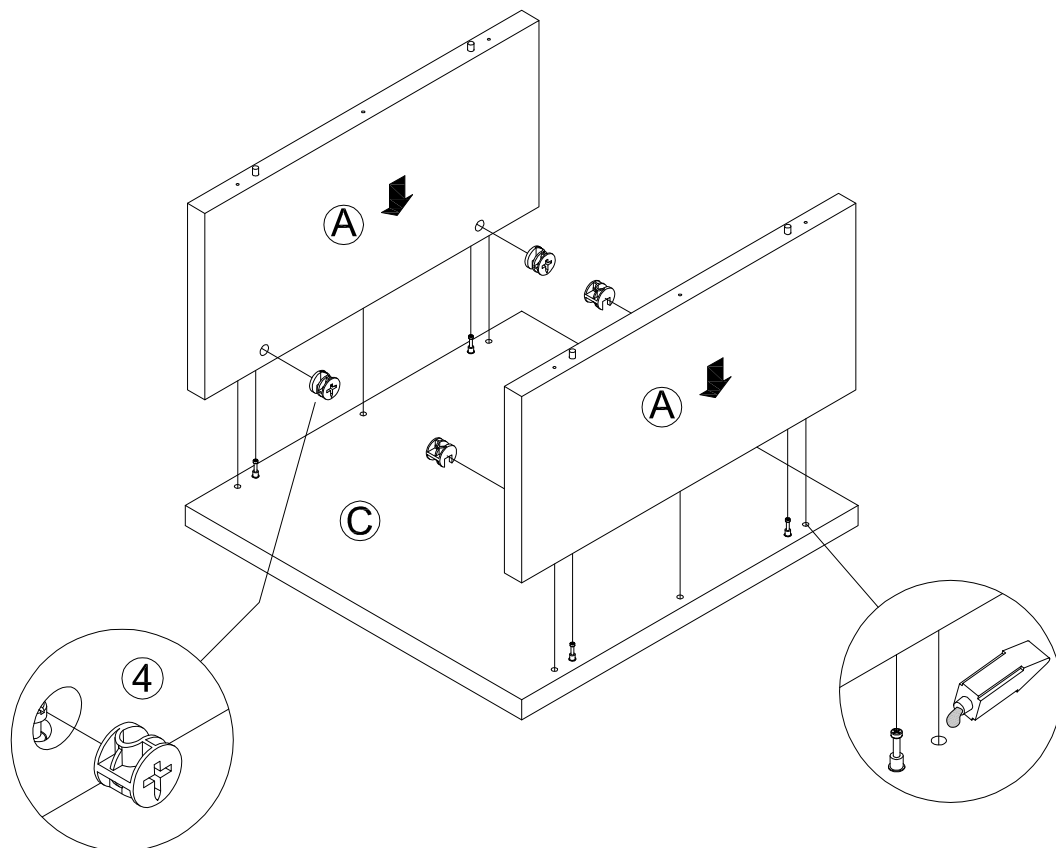

WHEN CAM BOLTS (3) IS ATTACHED, INSERT CAM CLOCKS (4)  
 AN TIGHTLY FASTEN BY TURNING CLOCKWISE.  
 SCHUIF DE CONNECTOR (4) ERIN ZODRA DE CONNECTOR PIN (3)  
 AANGEBRACHT IS EN BEVESTIG DEZE STEVIG DOOR MET DE  
 KLOK MEE TE DRAAIEN.

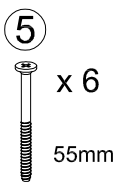

4

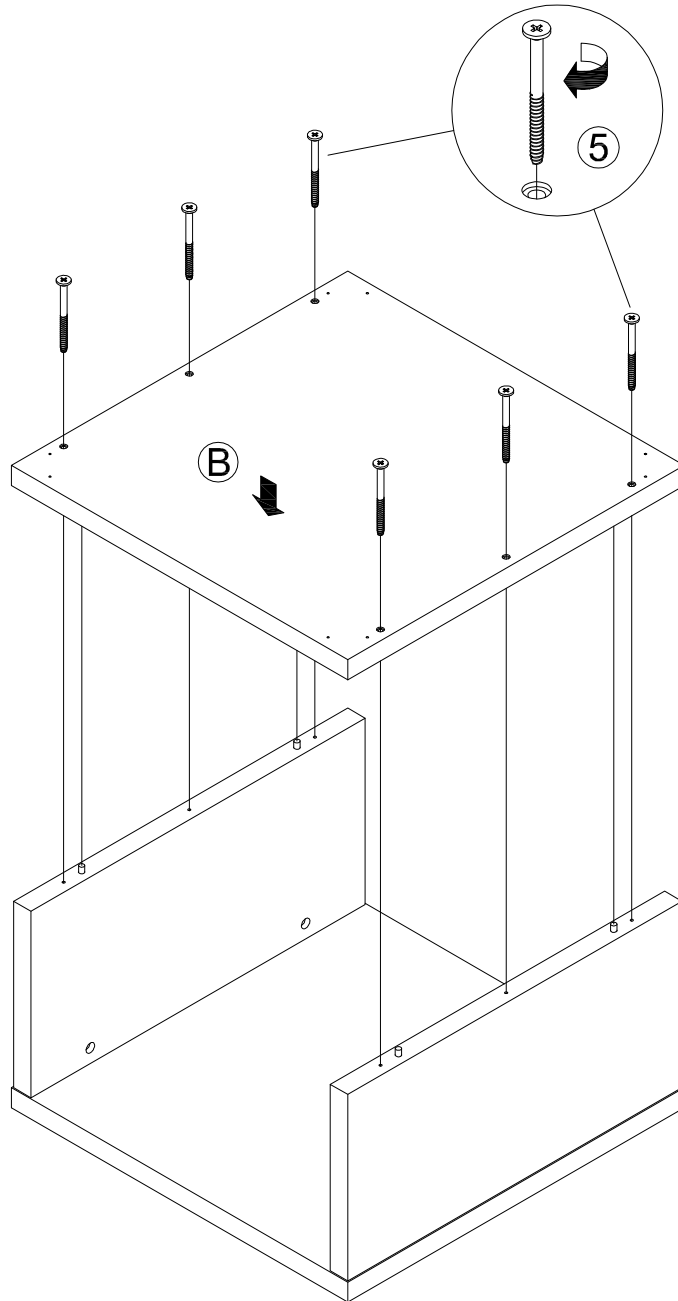

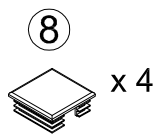
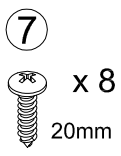
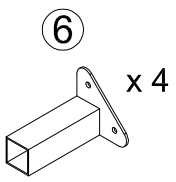

5

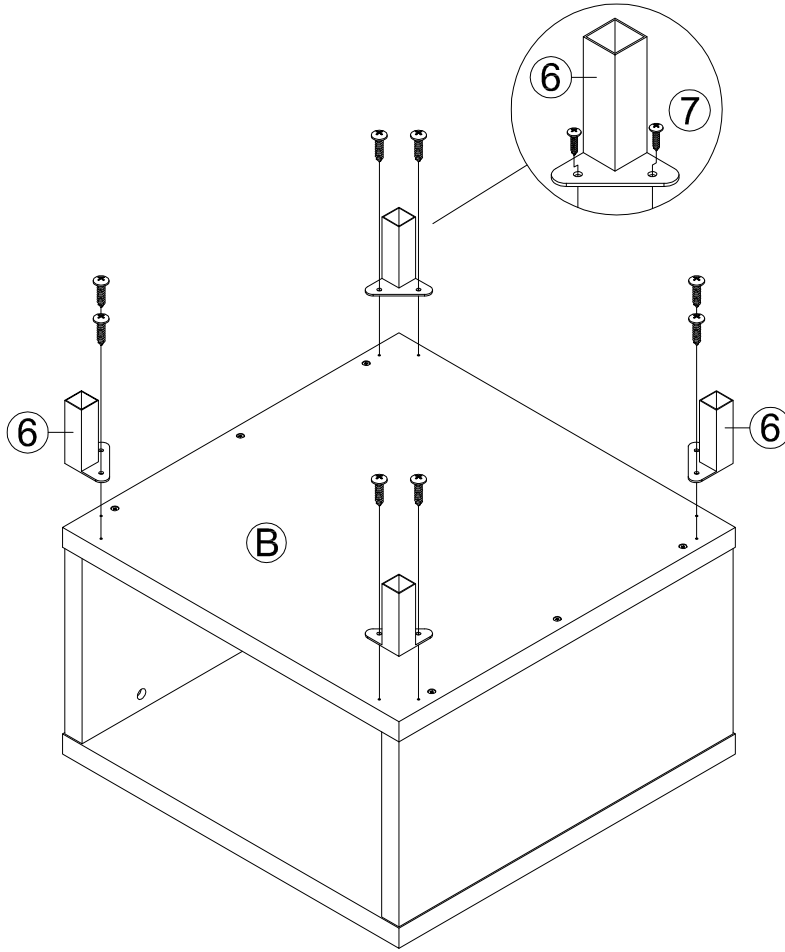

6

